

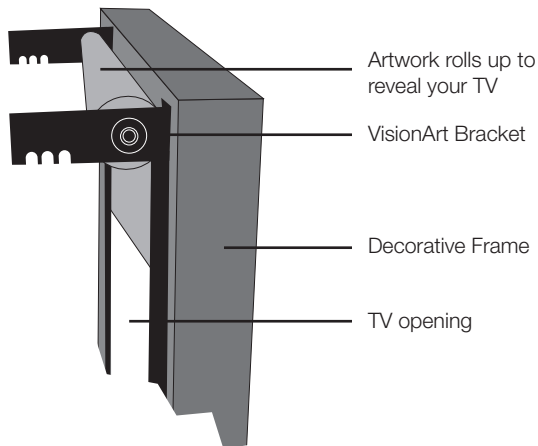

Disguise your TV
elegantly with VisionArt

DISGUISE AND DISPLAY

On your wall hangs the museum-quality, fine-art print you've chosen in a designer frame. **With the press of a button a quiet motor pulls the print upward and rolls it out of sight.** In its place is your flat-screen television, ready for viewing. Until now, it's been hidden from view without compromising the interior design of your room. When you turn off the television, the print descends to hide the TV once again.



THE ART OF THE PRINT

Each of VisionArt's museum-quality, fine-art prints are nearly indistinguishable from the original artwork. Every print is digitally produced by expert craftsmen using state-of-the-art giclée printing.

Giclée prints are of such quality, they are displayed in New York's Metropolitan Museum and Museum of Modern Art, as well as other highly respected galleries throughout the world. The prints are created from ultra-sensitive digital scans and an eight-color digital printer that sprays four million drops of color per inch on an archival quality canvas. No dot screen pattern is visible.

Each print is silk-screened with a varnish to enhance its color and protect the fine surface texture. All VisionArt prints adhere to archival standards consistent with collectible fine-art prints made to last a century.

VISIONART GALLERIES



The complete solution: the TRIO. The first LED HDTV, Frame and Fine-Art TV concealment system.



VisionArt's most exclusive collection of fine-art prints offering hundreds of limited edition images in a variety of categories. Each fine-art print is signed and numbered.



This collection consists of over 70 distinctive works of art and 15 designer frames to choose from, providing endless mix and match TV concealment options.



VisionArt's cost-effective way to conceal your TV. Choose from over 40 "unlimited edition" images and 9 designer frames, providing a broad range of mix and match TV concealment options.



LED HDTV + FRAME + ARTWORK



Front View



Side View

FEATURES INCLUDE:

Ultra Slim LED HDTV

Screen Extends less than 2-1/2" from the Wall

Smart TV featuring Web-Connect

TV Remote Operates Both TV & VisionArt

Eco-friendly Design with Energy Star Compliance

Chief® Thinstall™ Wall Mount

Delivered Ready-to-Install

For those who prefer a surface mounted system – VisionArt has the ideal solution: the TRIO, the first LED HDTV, Frame and Fine-Art TV concealment system available!

The TRIO's Ultra Slim LED HDTV screen and Chief® Thinstall™ Wall Mount extends less than 2-1/2" from the wall – it's virtually flat. The flat screen TV and VisionArt are controlled by the TV's IR remote and delivered ready-to-install.

Choose from 400+ art images and 150+ frames from the Premiere, Décor, and Expressions Galleries, or supply custom art.

VisionArt® | art over technology



See them all at visionartgalleries.com

premiere
gallerie

PREMIERE GALLERIE CATEGORIES

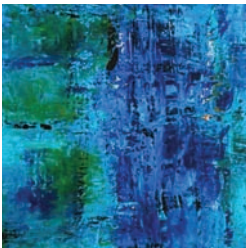

abstract



car art



figurative



florals



landscape

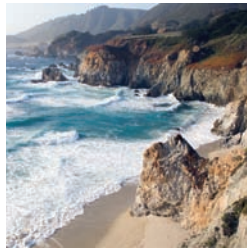

photography



seascape



still life



western

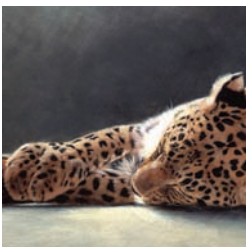

wildlife



asian art



custom art

VisionArt contracts with many of today's most acclaimed artists and photographers and is able to offer an exclusive collection of art and photographic images in three distinctive galleries.

The Premiere Gallerie presents limited edition images in different categories. This Gallerie is regularly updated with additional works from new and featured artists. Each Premiere Gallerie Fine-Art Print is signed and numbered by the original artist.

Client supplied artwork and photography for custom VisionArt orders is accepted in the Premiere and Décor Galleries.

Make it a TRIO! The first LED HDTV, Frame and Fine-Art TV concealment system available!

VisionArt® | art over technology

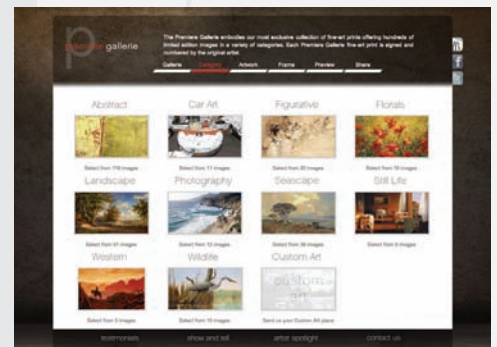

See them all at visionartgalleries.com

DÉCOR GALLERIE CATEGORIES



abstract



figurative



florals



landscape



photography

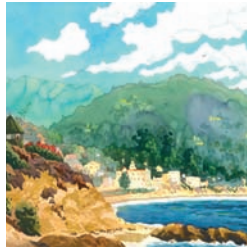

seascape



still life



wildlife



custom art



Features 70+ “unlimited edition” images and 15 designer frames, providing a more cost-effective way to conceal a television.

Images can be ordered with Premiere Gallerie frames at Premiere Gallerie pricing.

Client supplied artwork and photography for custom VisionArt orders is accepted in the Décor Gallerie.

Make it a TRIO! The first LED HDTV, Frame and Fine-Art TV concealment system available! See the TRIO Solution page.

EXPRESSIONS GALLERIE CATEGORIES



abstract



figurative



landscape

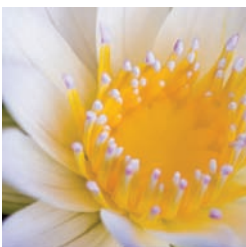

photography



seascape



A cost-effective way to conceal a television. Choose from over 40 “unlimited edition” images and nine designer frames, providing a broad range of mix and match TV concealment options.

Make it a TRIO! The first LED HDTV, Frame and Fine-Art TV concealment system available! See the TRIO Solution page.



VISIONART RECESSED INSTALLATION

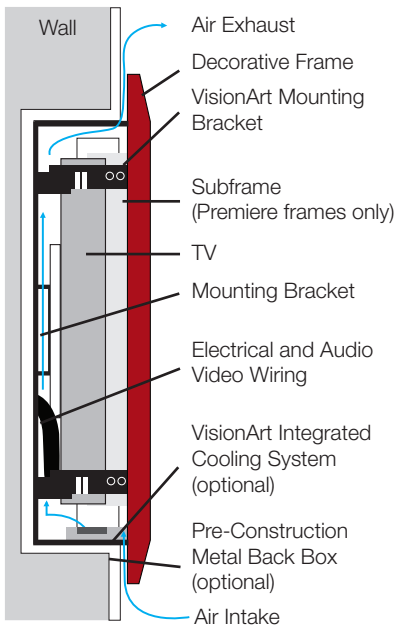

CAVITY DIMENSIONS

TV height +7"
 TV width +7"
 TV depth + mounting bracket depth

CAVITY OVERLAP

Frame will overlap the edge by at least 1/2". Some frames are wider and will overlap more.

TV OVERLAP

Inside of the frame will overlap the Plasma/TV by 1/2"

Recess mounting is most commonly used in a remodel or new construction and requires the carpentry of a built-in cavity to house both the TV and VisionArt subframe. Recess mounting is best visually and enables your VisionArt to be flush against the wall surface.

Surface mounting is commonly used when recess is not possible or desirable and provides esthetically pleasing results. In a surface mount application the TV and VisionArt are mounted directly onto the wall. Surface mounted units are typically installed with "returns". The returns are easily cut to fit the opening between the wall and the back of the VisionArt frame, effectively concealing the side view of the monitor and VisionArt mounting brackets.

VISIONART SURFACE INSTALLATION

DEPTH

TV depth
 TV mounting bracket depth

TV OVERLAP

The inside of the Decorative Frame will overlap the TV by 1/2" on all sides

SIDE TREATMENTS

Black returns are included and are mounted to the sides concealing the TV.

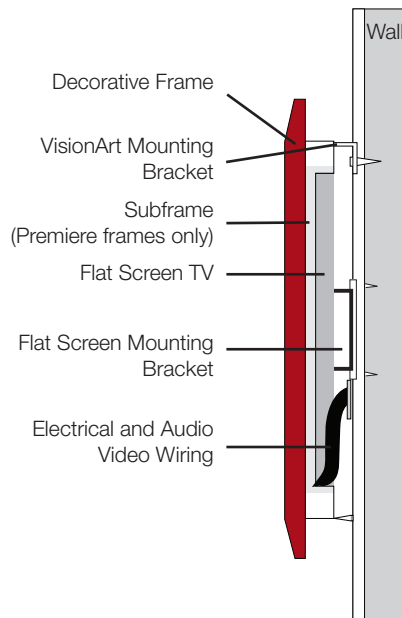

gallerie 23 frames

GALLERIE 23 FRAME SAMPLES



Aspen



Astor



Claridge

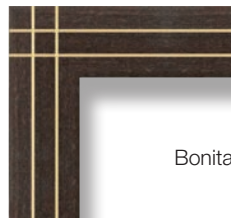

Bonita

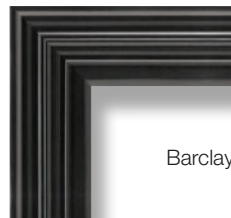

Barclay

For the collector - Gallerie 23 features twenty-three high-quality finished corner frames in a variety of elegant styles and premium finishes. Each frame is hand crafted using old world historic framing techniques and provides a distinctive look and seamless finished quality.

- Hand gilded lacquer, gold and metal leaf finishes.
- Custom finishes available.
- Various distinctive profiles.
- Seamless museum quality finished corners.
- Side “returns” available in the exact same finish as your frame.

Visit visionartgalleries.com to view the complete collection.

VisionArt® | art over technology

PREMIERE GALLERIE FRAMES



Florence

The Premiere Gallerie Frame collection offers more than 50 contemporary frames constructed from solid hardwood stock in a wide range of finishes and colors.

To view the complete selection of frames, profiles, finishes and materials, visit visionartgalleries.com

DÉCOR GALLERIE FRAMES

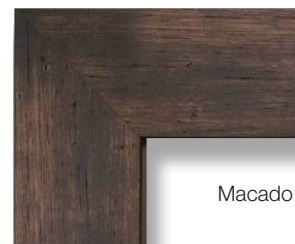

Macado

leather frames

LEATHER FRAME SAMPLES

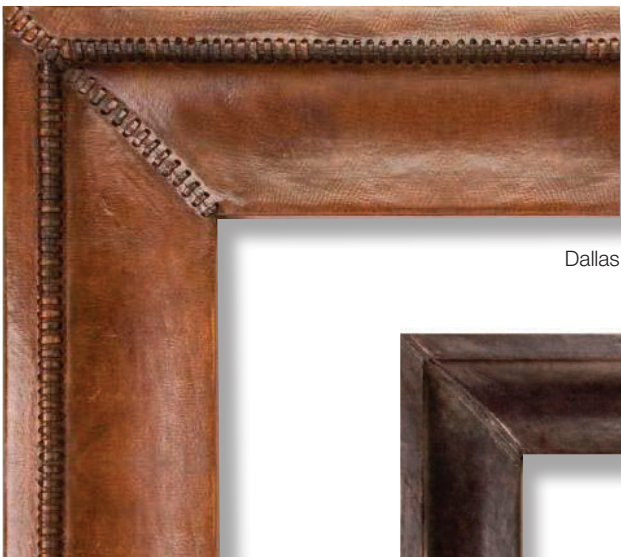

Dallas

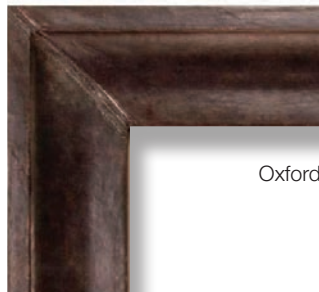

Oxford

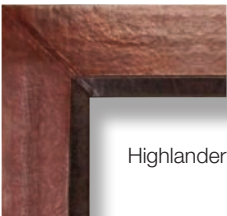

Highlander

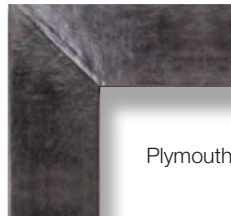

Plymouth

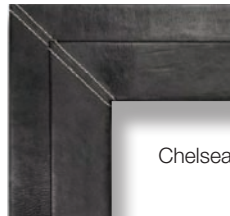

Chelsea

House of Mercier's Leather Frames come to VisionArt from Lima, Peru. Made by Peruvian saddle makers, these unique leather mouldings are crafted using ancient techniques more than 500 years old. Now crafting for the picture frame and furniture industry, these leather experts use only the highest quality products, creating beautiful hand-tooled patterns.

Carefully chosen cowhides are specially tanned to give the leather the right gage, durability, color, and texture. All frames are custom made, making each a one-of-a-kind piece of art. Purely amazing!

Visit visionartgalleries.com to view the complete collection.

VisionArt® | art over technology

A collection of classic profiles, complete with beautiful finishing touches.

To view the complete selection of frames, profiles, finishes and materials, visit visionartgalleries.com

EXPRESSIONS GALLERIE FRAMES



Nolan

A collection of frames that capture simplicity and sophistication.

To view the complete selection of frames, profiles, finishes and materials, visit visionartgalleries.com



CUSTOM ART



Showcase your favorite family photograph as your custom art.



Any public domain artwork can be used in your VisionArt.



Already own your favorite piece of art; we can make it a VisionArt.



Custom-build your VisionArt to any size.

Your unique vision, customized.

We understand that art is as individual as you are and we're aware you may prefer your own art or photography.

We gladly accept your supplied artwork for custom orders in our Premiere and Décor Galleries.

In addition to custom art we'll custom-build your VisionArt to any size, shape or orientation that will fit the proportions of a specific room.

VisionArt® | art over technology



See visionartgalleries.com for all options.



BUILD YOUR VISIONART ONLINE:



1. Select a fine-art print from the Galerie of your choice.



2. Choose a frame from options shown below selected print.



3. Preview your selected print and frame by clicking on icon on the left. Choose your wall color to get a realistic preview.

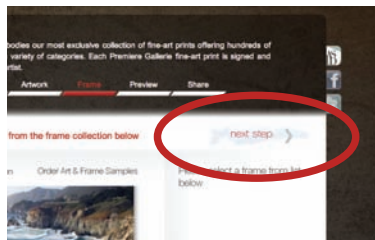

4. Close wall preview and click on next step on top right to send your order for review.



5. Click on view larger to open your print and frame choice in another window.



6. Fill out required fields and view larger image before submitting. A VisionArt representative will contact you or send to authorized dealer for ordering.

Create your own custom design online at visionartgalleries.com.

Mix and match artwork and frames to build your masterpiece.

Need help? Call us, and a personal assistant will walk you through the process.

Call 866.432.4353

VisionArt® | art over technology

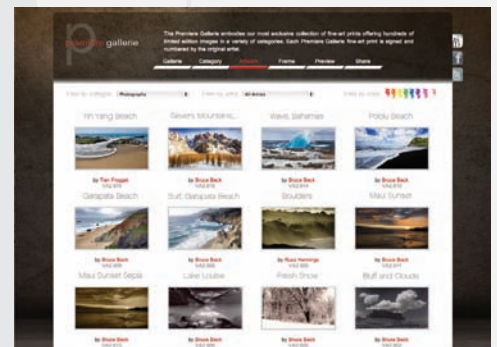

See visionartgalleries.com for all options.

VisionArt®

866.432.4353
visionartgalleries.com
info@visionartgalleries.com